

POWER MOS 7® IGBT

A new generation of high voltage power IGBTs. Using punch-through technology and a proprietary metal gate, this IGBT has been optimized for very fast switching, making it ideal for high frequency, high voltage switch-mode power supplies and tail current sensitive applications. In many cases, the POWER MOS 7® IGBT provides a lower cost alternative to a Power MOSFET.

- **Low Conduction Loss**
- **Low Gate Charge**
- **Ultrafast Tail Current shutoff**
- **100 kHz operation @ 800V, 7A**
- **50 kHz operation @ 800V, 12A**
- **RBSOA Rated**

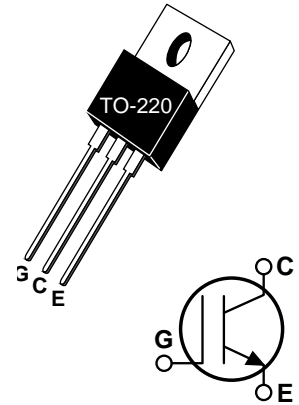

MAXIMUM RATINGS

All Ratings: $T_C = 25^\circ\text{C}$ unless otherwise specified.

Symbol	Parameter	APT13GP120K	UNIT
V_{CES}	Collector-Emitter Voltage	1200	Volts
V_{GE}	Gate-Emitter Voltage	± 20	
V_{GEM}	Gate-Emitter Voltage Transient	± 30	
I_{C1}	Continuous Collector Current @ $T_C = 25^\circ\text{C}$	43	Amps
I_{C2}	Continuous Collector Current @ $T_C = 110^\circ\text{C}$	21	
I_{CM}	Pulsed Collector Current ^① @ $T_C = 25^\circ\text{C}$	84	
RBSOA	Reverse Bias Safe Operating Area @ $T_J = 150^\circ\text{C}$	84A @ 960V	
P_D	Total Power Dissipation	290	Watts
T_J, T_{STG}	Operating and Storage Junction Temperature Range	-55 to 150	$^\circ\text{C}$
T_L	Max. Lead Temp. for Soldering: 0.063" from Case for 10 Sec.	300	

STATIC ELECTRICAL CHARACTERISTICS

Symbol	Characteristic / Test Conditions	MIN	TYP	MAX	UNIT
BV_{CES}	Collector-Emitter Breakdown Voltage ($V_{GE} = 0V, I_C = 250\mu A$)	1200			Volts
$V_{GE(TH)}$	Gate Threshold Voltage ($V_{CE} = V_{GE}, I_C = 1mA, T_J = 25^\circ\text{C}$)	3	4.5	6	
$V_{CE(ON)}$	Collector-Emitter On Voltage ($V_{GE} = 15V, I_C = 13A, T_J = 25^\circ\text{C}$)		3.6	3.9	
	Collector-Emitter On Voltage ($V_{GE} = 15V, I_C = 13A, T_J = 125^\circ\text{C}$)		3.1		
I_{CES}	Collector Cut-off Current ($V_{CE} = V_{CES}, V_{GE} = 0V, T_J = 25^\circ\text{C}$) ^②			250	μA
	Collector Cut-off Current ($V_{CE} = V_{CES}, V_{GE} = 0V, T_J = 125^\circ\text{C}$) ^②			2500	
I_{GES}	Gate-Emitter Leakage Current ($V_{GE} = \pm 20V$)			± 100	nA

 **CAUTION:** These Devices are Sensitive to Electrostatic Discharge. Proper Handling Procedures Should Be Followed.

DYNAMIC CHARACTERISTICS

APT13GP120K

Symbol	Characteristic	Test Conditions	MIN	TYP	MAX	UNIT	
C_{ies}	Input Capacitance	Capacitance $V_{GE} = 0V, V_{CE} = 25V$ $f = 1 \text{ MHz}$		1093		pF	
C_{oes}	Output Capacitance			133			
C_{res}	Reverse Transfer Capacitance			35			
V_{GEP}	Gate-to-Emitter Plateau Voltage	Gate Charge $V_{GE} = 15V$ $V_{CE} = 600V$ $I_C = 13A$		8		V	
Q_g	Total Gate Charge ^③			65		nC	
Q_{ge}	Gate-Emitter Charge			7			
Q_{gc}	Gate-Collector ("Miller") Charge			32			
RBSOA	Reverse Bias Safe Operating Area	$T_J = 150^\circ\text{C}, R_G = 5\Omega, V_{GE} = 15V, L = 100\mu\text{H}, V_{CE} = 960V$	84			A	
$t_{d(on)}$	Turn-on Delay Time	Inductive Switching (25°C) $V_{CC} = 800V$ $V_{GE} = 15V$ $I_C = 13A$ $R_G = 5\Omega$ $T_J = +25^\circ\text{C}$		8		ns	
t_r	Current Rise Time			23			
$t_{d(off)}$	Turn-off Delay Time			35			
t_f	Current Fall Time			89			
E_{on1}	Turn-on Switching Energy ^④				340		μJ
E_{on2}	Turn-on Switching Energy (Diode) ^⑤				892		
E_{off}	Turn-off Switching Energy ^⑥				332		
$t_{d(on)}$	Turn-on Delay Time		Inductive Switching (125°C) $V_{CC} = 800V$ $V_{GE} = 15V$ $I_C = 13A$ $R_G = 5\Omega$ $T_J = +125^\circ\text{C}$		8		ns
t_r	Current Rise Time			23			
$t_{d(off)}$	Turn-off Delay Time			58			
t_f	Current Fall Time			157			
E_{on1}	Turn-on Switching Energy ^④				384		μJ
E_{on2}	Turn-on Switching Energy (Diode) ^⑤				1262		
E_{off}	Turn-off Switching Energy ^⑥				715		

THERMAL AND MECHANICAL CHARACTERISTICS

Symbol	Characteristic	MIN	TYP	MAX	UNIT
$R_{\theta JC}$	Junction to Case (IGBT)			.43	$^\circ\text{C/W}$
$R_{\theta JC}$	Junction to Case (DIODE)			N/A	
W_T	Package Weight			5.90	gm

- ① Repetitive Rating: Pulse width limited by maximum junction temperature.
- ② For Combi devices, I_{ces} includes both IGBT and FRED leakages
- ③ See MIL-STD-750 Method 3471.
- ④ E_{on1} is the clamped inductive turn-on-energy of the IGBT only, without the effect of a commutating diode reverse recovery current adding to the IGBT turn-on loss. (See Figure 24.)
- ⑤ E_{on2} is the clamped inductive turn-on energy that includes a commutating diode reverse recovery current in the IGBT turn-on switching loss. A Combi device is used for the clamping diode as shown in the E_{on2} test circuit. (See Figures 21, 22.)
- ⑥ E_{off} is the clamped inductive turn-off energy. (See Figures 21, 23.)

APT Reserves the right to change, without notice, the specifications and information contained herein.

TYPICAL PERFORMANCE CURVES

APT13GP120K

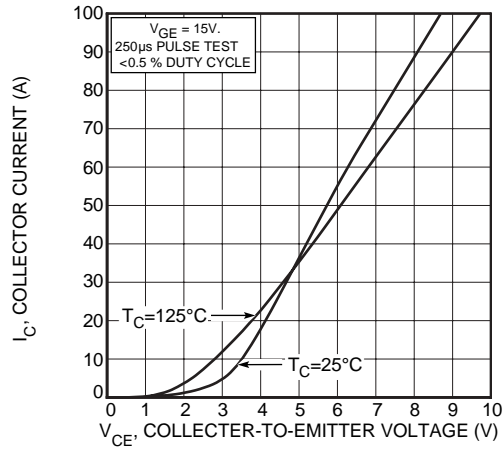

FIGURE 1, Output Characteristics ($V_{GE} = 15V$)

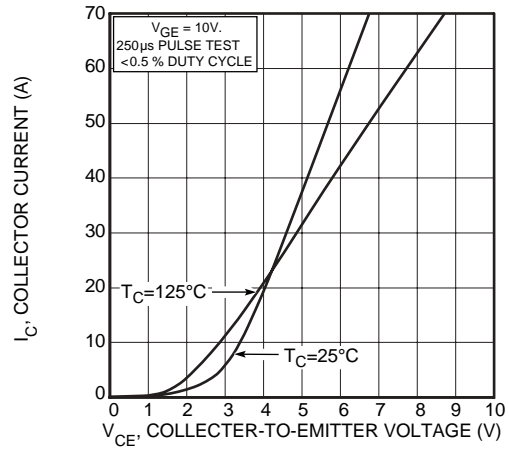

FIGURE 2, Output Characteristics ($V_{GE} = 10V$)

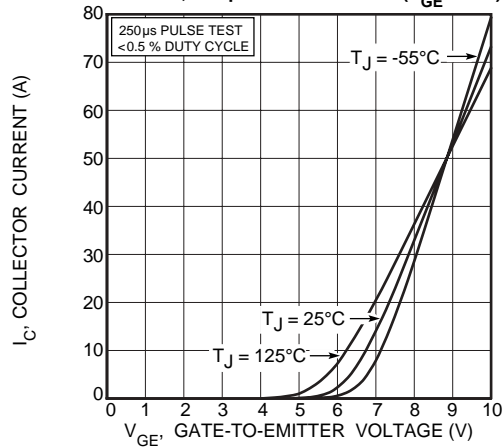

FIGURE 3, Transfer Characteristics

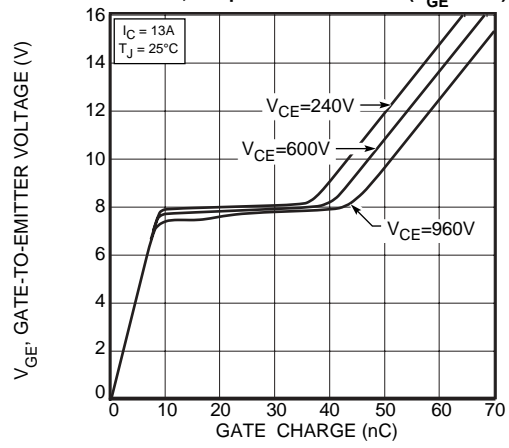

FIGURE 4, Gate Charge

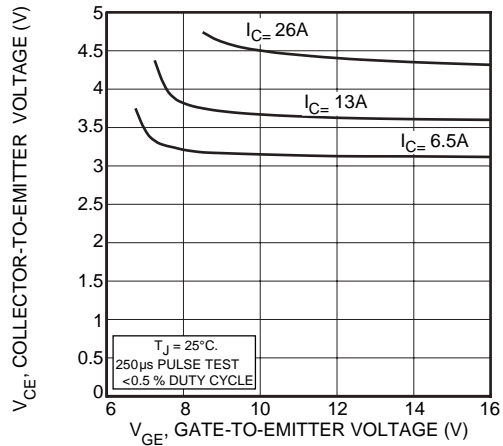

FIGURE 5, On State Voltage vs Gate-to-Emitter Voltage

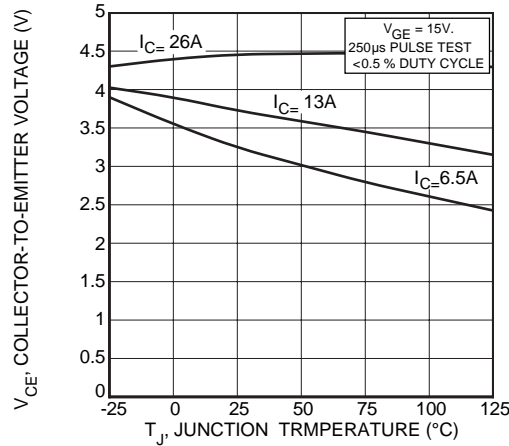

FIGURE 6, On State Voltage vs Junction Temperature

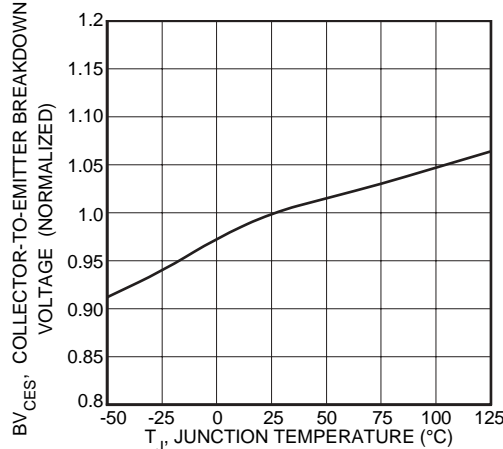

FIGURE 7, Breakdown Voltage vs. Junction Temperature

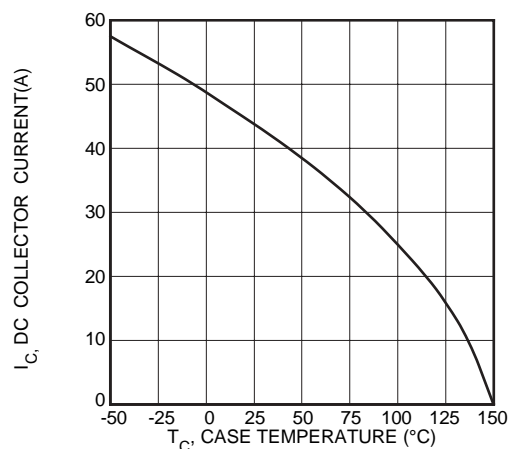

FIGURE 8, DC Collector Current vs Case Temperature

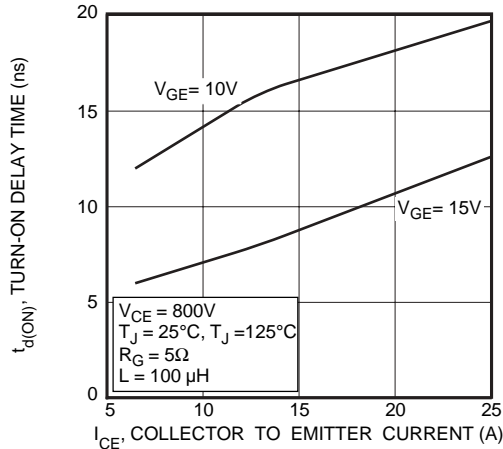

FIGURE 9, Turn-On Delay Time vs Collector Current

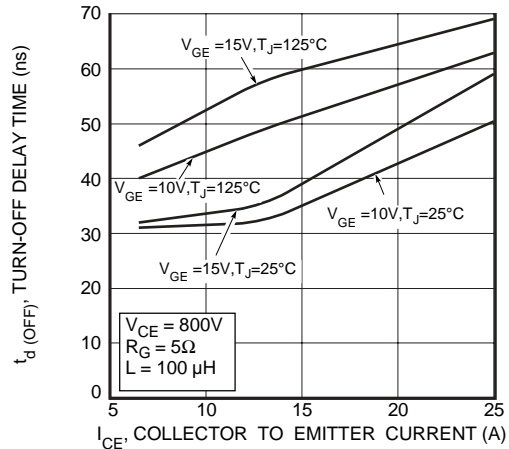

FIGURE 10, Turn-Off Delay Time vs Collector Current

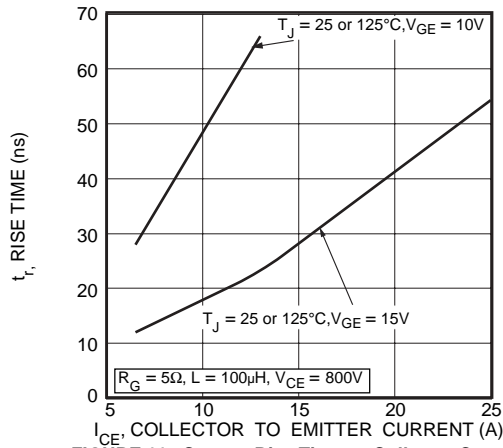

FIGURE 11, Current Rise Time vs Collector Current

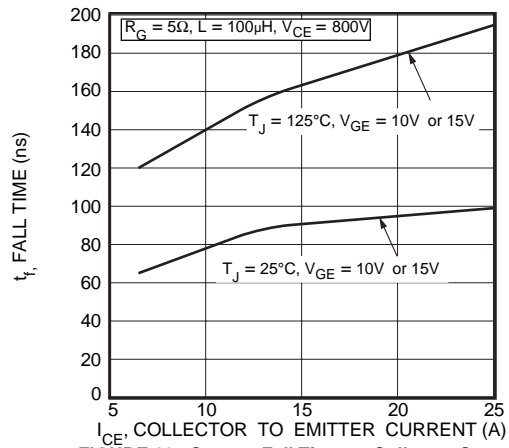

FIGURE 12, Current Fall Time vs Collector Current

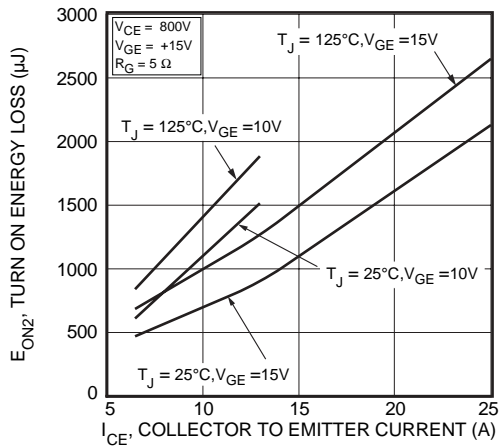

FIGURE 13, Turn-On Energy Loss vs Collector Current

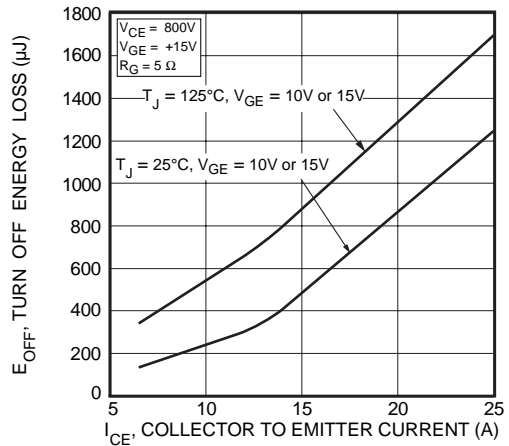

FIGURE 14, Turn Off Energy Loss vs Collector Current

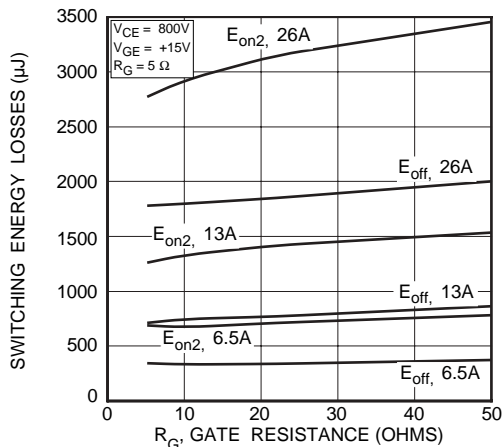

FIGURE 15, Switching Energy Losses vs. Gate Resistance

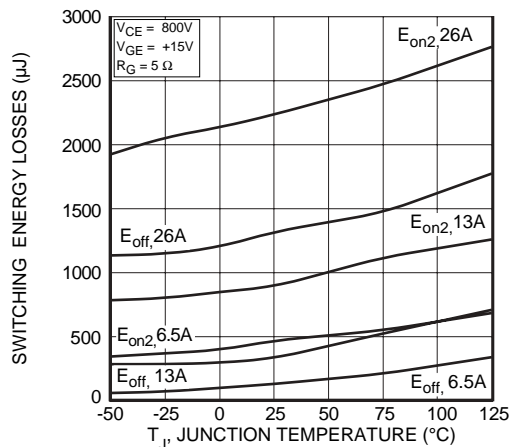

FIGURE 16, Switching Energy Losses vs Junction Temperature

TYPICAL PERFORMANCE CURVES

APT13GP120K

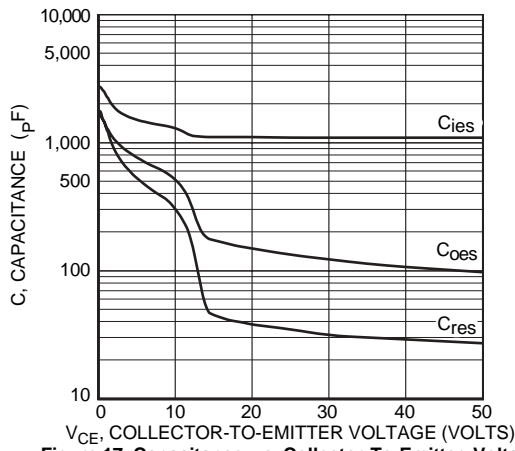

Figure 17, Capacitance vs Collector-To-Emitter Voltage

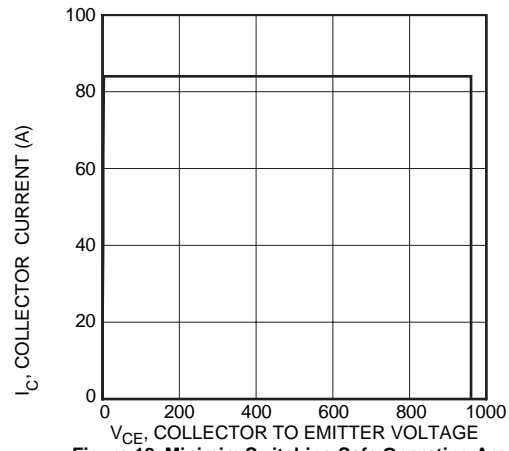

Figure 18, Minimum Switching Safe Operating Area

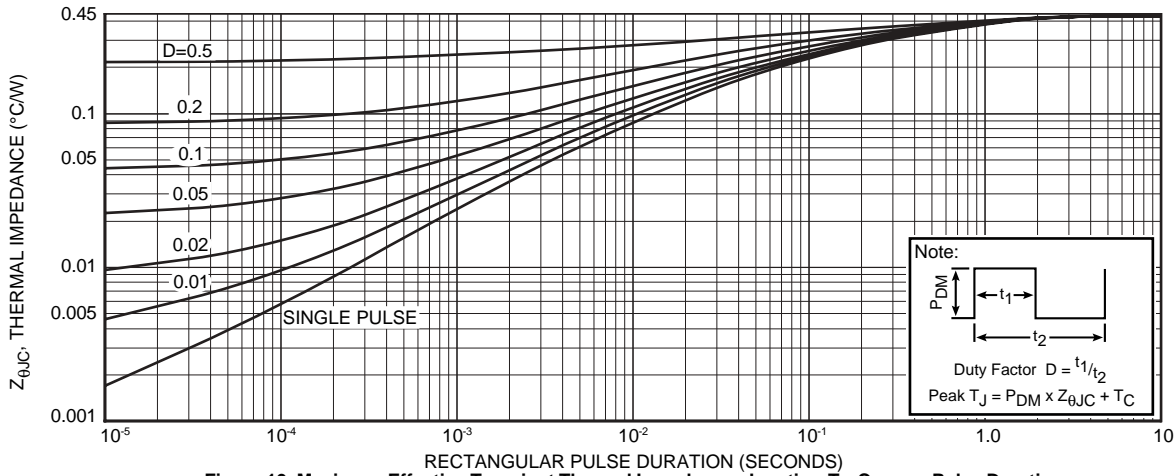

Figure 19, Maximum Effective Transient Thermal Impedance, Junction-To-Case vs Pulse Duration

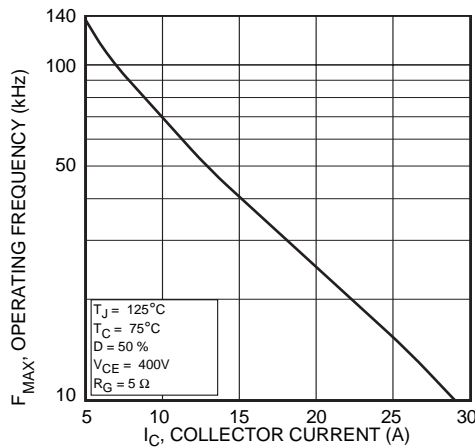

Figure 20, Operating Frequency vs Collector Current

$$F_{max} = \min(f_{max1}, f_{max2})$$

$$f_{max1} = \frac{0.05}{t_{d(on)} + t_r + t_{d(off)} + t_f}$$

$$f_{max2} = \frac{P_{diss} - P_{cond}}{E_{on2} + E_{off}}$$

$$P_{diss} = \frac{T_J - T_C}{R_{\theta JC}}$$

$T_J = 125^\circ C$
 $T_C = 75^\circ C$
 $D = 50\%$
 $V_{CE} = 400V$
 $R_G = 5 \Omega$

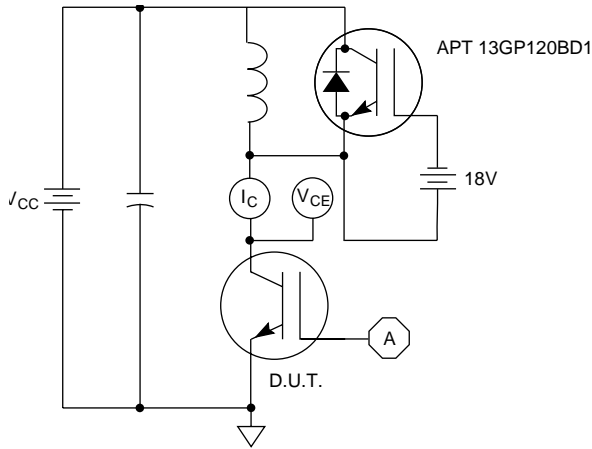

Figure 21, Inductive Switching Test Circuit

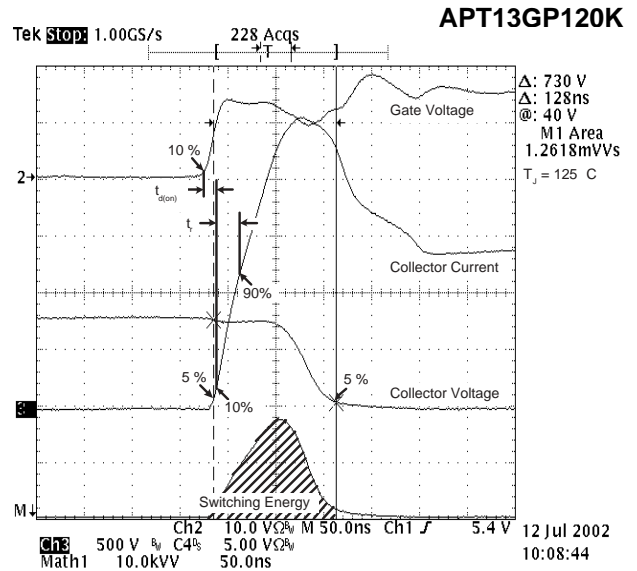

Figure 22, Turn-on Switching Waveforms and Definitions

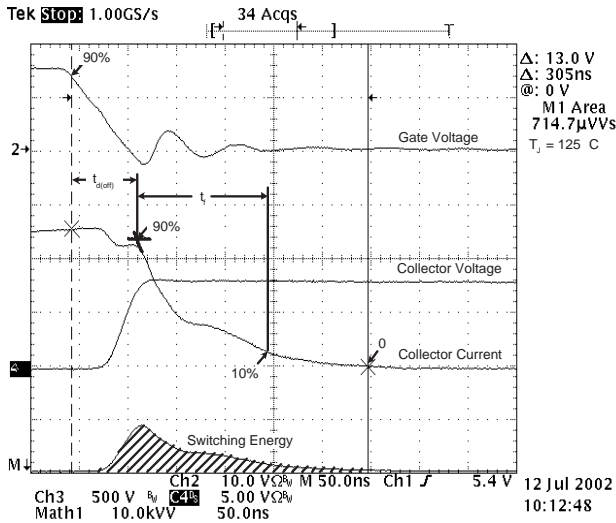

Figure 23, Turn-off Switching Waveforms and Definitions

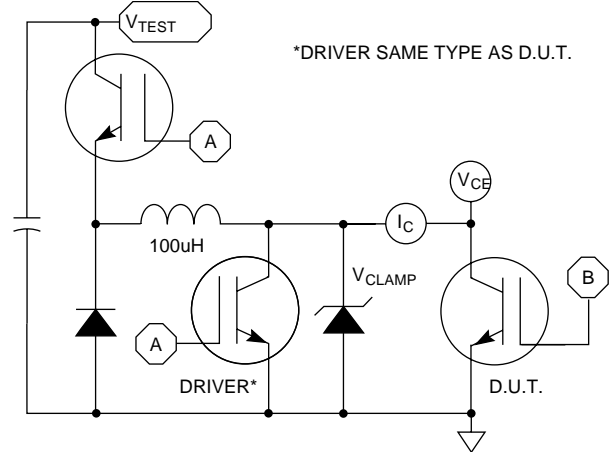
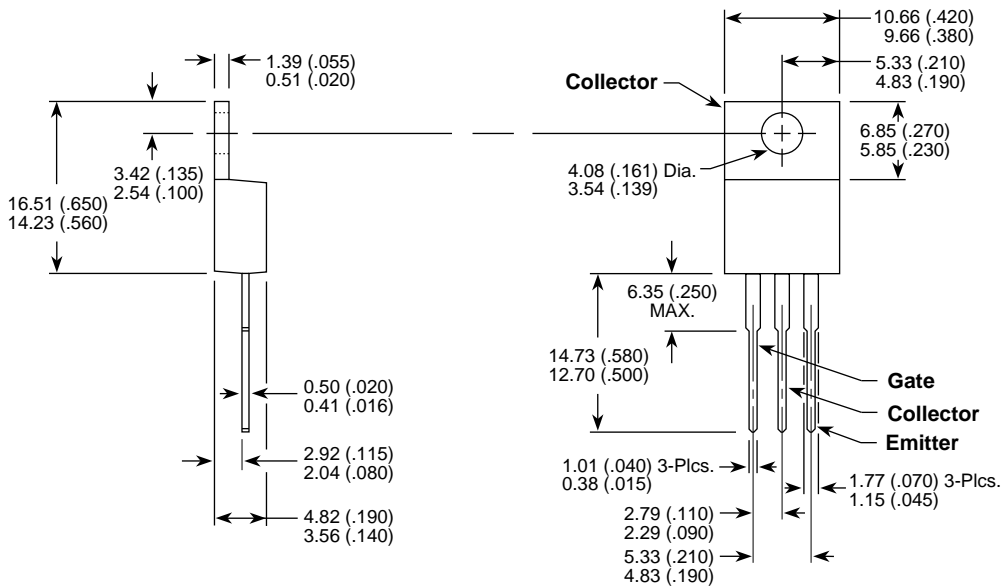

Figure 24, E_{ON1} Test Circuit

TO-220AC Package Outline



Dimensions in Millimeters and (Inches)

APT's devices are covered by one or more of the following U.S.patents: 4,895,810 5,045,903 5,089,434 5,182,234 5,019,522 5,262,336
 5,256,583 4,748,103 5,283,202 5,231,474 5,434,095 5,528,058